

# Hisense

## ***USER MANUAL***

Before using the TV, please read this manual thoroughly and retain it for future reference.

ENGLISH

---

# Copyright Statement

---

© 2021 Hisense Company Ltd. All Rights Reserved.

All material in this User Manual is the property of Hisense Company Ltd. and its subsidiaries, and is protected under US, CANADA, MEXICO and International copyright and/or other intellectual property laws. Reproduction or transmission of the materials, in whole or in part, in any manner, electronic, print, or otherwise, without the prior written consent of Hisense Company Ltd. is a violation of Hisense Company Ltd. rights under the aforementioned laws.

No part of this publication may be stored, reproduced, transmitted or distributed, in whole or in part, in any manner, electronic or otherwise, whether or not for a charge or other or no consideration, without the prior written permission of Hisense Company Ltd.

Requests for permission to store, reproduce, transmit or distribute materials may be made to one of the following addresses:

USA: Hisense USA Corporation  
7310 McGinnis Ferry Road  
Suwanee, GA 30024

CANADA: Hisense Canada Co., Ltd  
2283 Argentia Road, Unit 16  
Mississauga, ON, Canada  
L5N 5Z2

MEXICO: Hisense Mexico S. de R.L. de C.V.  
Blvd. Miguel de Cervantes Saavedra No 301  
Torre Norte Piso 2, Col. Ampliación Granada  
Miguel Hidalgo, Ciudad de México, C.P. 11520  
RFC: HME110512IY3  
TEL: (52) (55) 5531-3515

Hisense, and any and all other Hisense product names, logo's, slogans or marks are registered trademarks of Hisense Company Ltd. and its subsidiaries. All other trademarks are the property of their respective holders.

©2021. All rights reserved. Hisense and the Hisense logo are registered trademarks of Hisense. Other brand and product names are registered trademarks of their respective owners.

## Disclaimer Page

\*\*Notwithstanding anything to the contrary, including in any or all descriptions, representations, statements or other communications related to this Hisense device (hereinafter "Device") made in any form whatsoever and at any time, some or all of the pre-installed, or subsequently installed Application Services may not be available or capable of functioning as intended by the provider of the Application Services in any or all usage areas for reasons outside of Hisense's control, including but not limited to, Internet access, local service limitations, etc. Any purchase or use of the Device, including any Application Services, is purely at the user's risk. Application Services are provided on an as-available basis without warranties of any kind, either expressed or implied, that the Application Service will be uninterrupted or error-free, including but not limited to vagaries of weather, disruption of Service, acts of God, warranties of title, local or regional limitations, no infringement, NOR IMPLIED WARRANTIES OF MERCHANTABILITY OR FITNESS FOR A PARTICULAR PURPOSE. No advice or information given by Hisense, providers, affiliates, or contractors or their respective employees shall create such a warranty. Hisense specifically disclaims responsibility for any or all Application Services from functioning at any time, and by purchasing the Device, you accept such disclaimer without any claim on Hisense. You are solely responsible for providing an active and working connection to the Internet, along with any and all hardware and/or software necessary to use the Hisense Device as intended.

**Disclaimer:**

**Images throughout this document are for illustrative purposes only and may differ from the actual product.**

# Contents

## Live TV

Channel Scan.....	4
Channel List.....	4
Favorite.....	5

## Connection

Establishing a Wired Internet Connection.....	8
Establishing a Wireless Internet Connection.....	8
Connecting Bluetooth Devices.....	9
Using HDMI&CEC.....	9
Connecting a Digital Audio System to Use eARC/ARC.....	10
Connecting an AV device, a PC or a Game Console with an HDMI cable.....	10
Connecting USB Devices.....	11

## Multi-screen

Screen Sharing.....	12
Content Sharing.....	12

## Smart Functions

Getting Familiar with the Home Screen.....	14
Using Voice Control.....	15
Media.....	17
Apps.....	19
Installing Mobile App to Control your TV.....	20

## Picture and Sound

Adjusting the Picture Quality.....	21
Game Mode Settings.....	24
Adjusting the Sound Quality.....	24

## Accessibility and System

Accessibility.....	27
Using Parental Control.....	27
Configuring Device Preferences Settings.....	28
Configuring Advanced System Settings.....	30
Projection Mode.....	32
Screen Type.....	32
Auto Geometric Correction.....	32
Geometric Correction.....	33
Eye Protection.....	34

## Troubleshooting

# Contents

Picture Issues.....	35
Sound Issues.....	35
Network Issues.....	36
External Device Connection Issues.....	36
Apps.....	37
Media Files.....	37
Voice Control Issues.....	37
Other Issues.....	38

## **Using the E-Manual**

Launching the E-Manual.....	39
Using the Buttons in the E-Manual.....	39

## Channel Scan

---

You can scan channels automatically or manually.

Note:

- Antenna/cable function may not be applicable in some models/countries/regions.

### Auto Scan

Automatically scan for channels to view programmes from your TV source.

 > **Channels**

If no TV channels were saved before, you will be prompted to do a channel search.

or

In Live TV,  > **Channels** > **Auto Channel Scan**

Before you select Auto Channel Scan, you can press  > **Channels** > **Tuner Mode** to select Antenna or Cable.

### Manual Scan

In Live TV,  > **Channels** > **Manual Scan**

Type in a channel to add it manually to your TV.

## Channel List

---

### Displaying the channel list

In Live TV, press  button on the remote to display the Channel List menu.

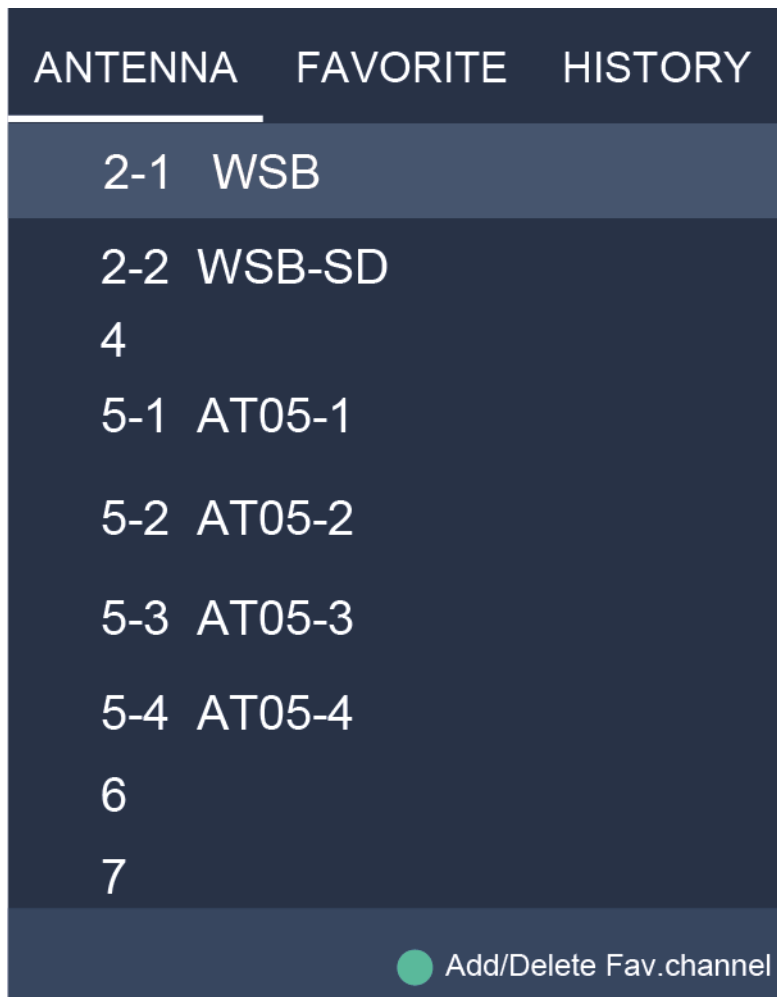



## Channel list menu

### Favorite

---

#### Viewing your favorite list

Press  button to call out the Channel list, and the channel list appears on the right side of the screen. Press  button and select green icon and then press  button, a heart-shaped icon will appear next to your favorite channel on ANTENNA/CABLE list, and the favorite channel will appear in the favorite list.

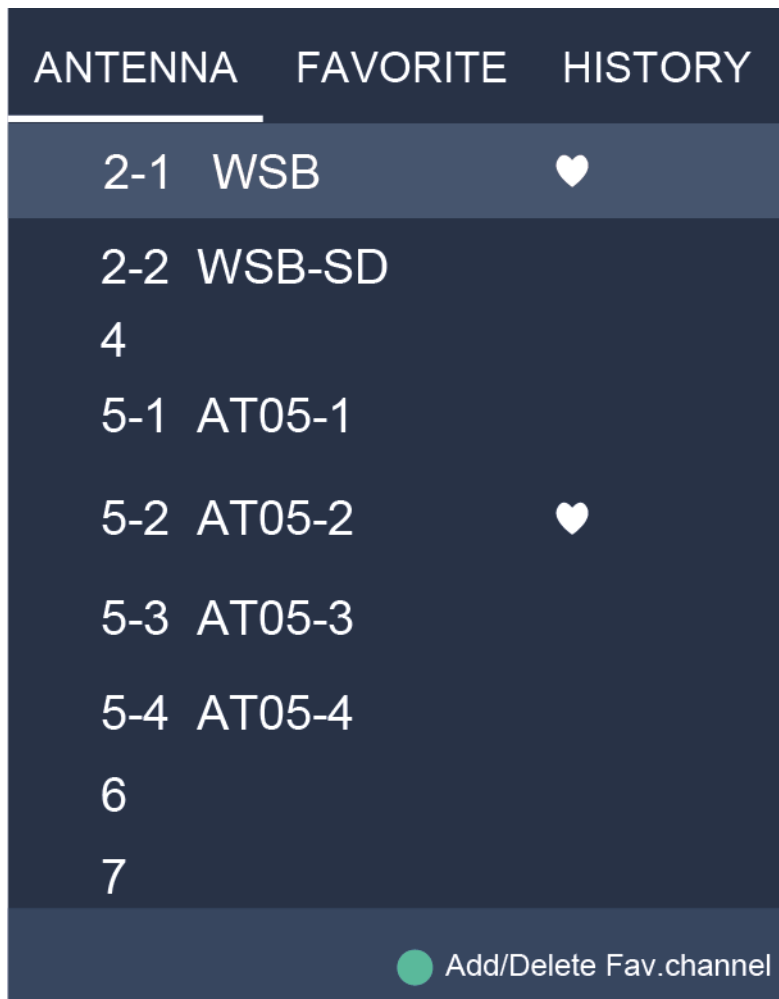

Channel list menu



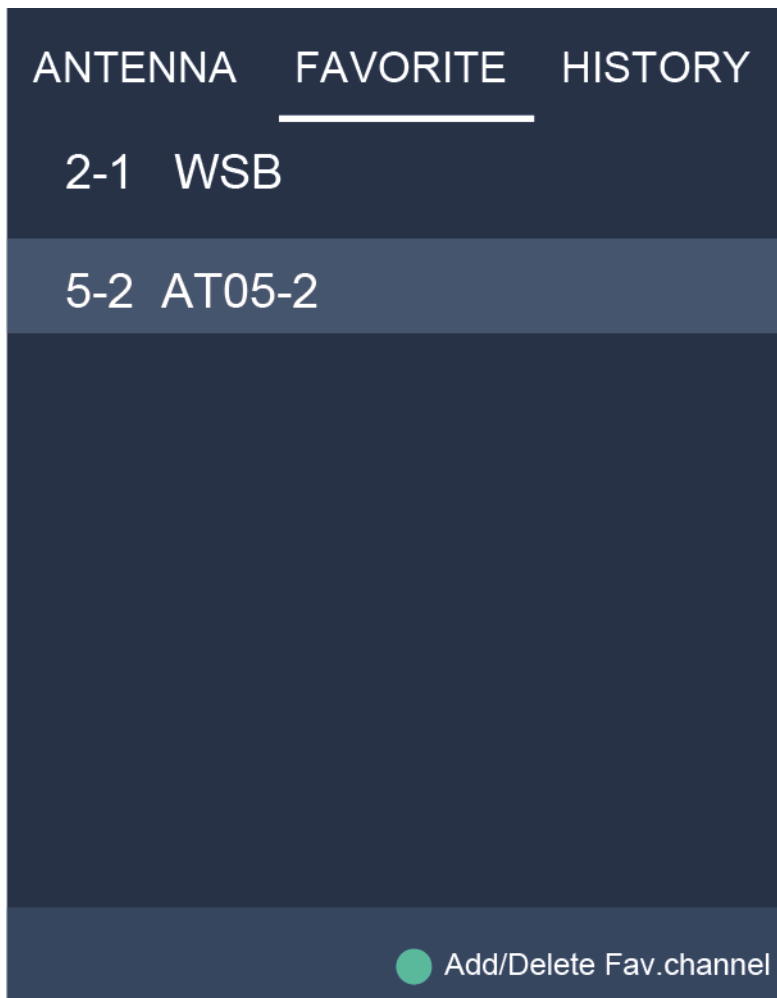

## Channel list menu

If you want to remove favorite channels, Press  button and select green icon and then press  button, a heart-shaped icon will disappear on ANTENNA/CABLE list.

Note:

- These steps should be operated under TV inputs.
- Before you edit the favorite lists, complete channel scan first.

## Establishing a Wired Internet Connection

### Connecting to a wired (Ethernet) network

Press  button to select  icon to enter **Network & Internet**.

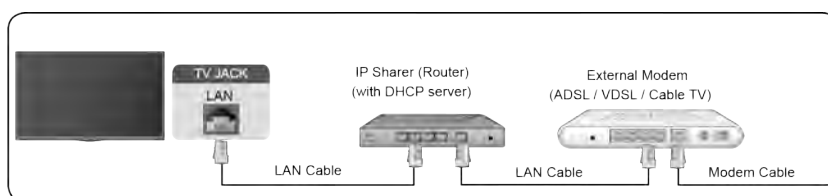

To get access to the Internet in a wired way, it is recommended to use a modem or router that supports Dynamic Host Configuration Protocol (DHCP). Modems and routers that support DHCP automatically provide the IP address, subnet mask, gateway, and DNS, so you don't have to enter them manually. Most home networks already have DHCP.

See the illustration below.



## Establishing a Wireless Internet Connection

### Connecting to a wireless network

Press  button to select  icon, and select **Network & Internet > Wi-Fi**

To connect to an available wireless network, make sure that you have the wireless router's SSID and password before attempting to connect.

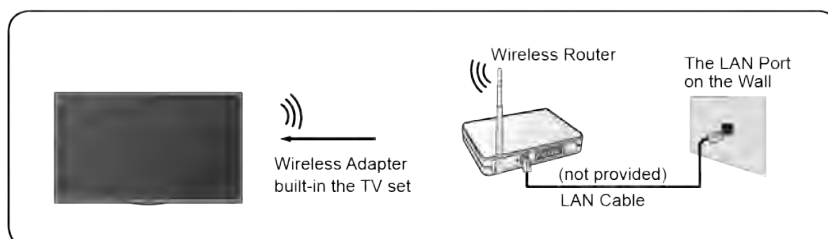

To get access to the Internet in a wireless way:



1. Turn on your Wi-Fi.
2. The list of networks will display automatically.
3. Select a wireless network from the list, input the password.
4. If the network connection does not appear in the list, select **See all** to display all the list, or select **Add new network** to input a Wi-Fi name, select the type of security mode, and enter password.

## Connecting Bluetooth Devices

---

### Connecting a Bluetooth device



To pair a Bluetooth device, such as Bluetooth headphones, speakers, keyboards, mouse or even mobile devices:

1. Before pairing your Bluetooth devices, make sure they're in pairing mode and put devices within range of the TV. To put your Bluetooth devices in pairing mode, refer to the user manual of devices.
2. Press  button to select  icon, and select **Remotes & Accessories > Add accessory** to put the TV in pairing mode. A list of available Bluetooth devices will be displayed.
3. Select the desired device from the list, then follow the onscreen instructions. If you are prompted to enter a passcode, refer to the user manual of the device. After pairing is completed, the device is connected and is stored to the TV.

Note:

- You need to unpair a paired device first if the maximum number of paired devices was reached.

### Listening to the TV through Bluetooth devices

1. Pair the Bluetooth audio devices using the TV's Bluetooth function. Refer to the user manual of your audio device such as Bluetooth speaker, sound bar and headphones for detailed connection steps and usage.
2. Press  button to select  icon, select **Sound > Audio Output**, and then select the **Bluetooth** option to listen to the audio through bluetooth devices.

Note:

- Compatibility issues may occur depending on the Bluetooth device.
- The TV and Bluetooth device may disconnect depending on the distance between them.

## Using HDMI&CEC

---



Use the TV's remote to control external devices that are connected to the TV by an HDMI cable. The external devices need to support HDMI&CEC function.

### Connecting an external device through HDMI&CEC function

Press  button to select  icon, and select **Inputs > HDMI control**.



1. Set **HDMI control** to On.
2. Connect an HDMI&CEC compliant device to the TV.
3. Turn on the connected external device. The device is automatically connected to the TV. After connection is finished, you can access the menu of the connected device on your TV screen using your TV remote and control the device.

### Enabling device auto power off

Press  button to select  icon, and select **Inputs > Device auto power off**.

Set to On to turn off CEC compatible external devices when the TV is turned off.

### Enabling TV auto power on

Press  button to select  icon, and select **Inputs > TV auto power on**.

## Connection

Set to On to turn on the TV when CEC compatible external devices is turned on.

Note:

- HDMI cables must be used to connect HDMI&CEC compatible devices to your TV.
- The HDMI&CEC feature of the connected device must be turned on.
- If you connect an HDMI device that is not HDMI&CEC compatible, all the HDMI&CEC control features do not work.
- Depending on the connected HDMI device, the HDMI&CEC control feature may not work.
- The HDMI&CEC feature are supported One Touch Play, Routing Control, System Standby, Device OSD Name Transfer, Remote Control Pass Through, Give Device Power Status, System Audio Control.

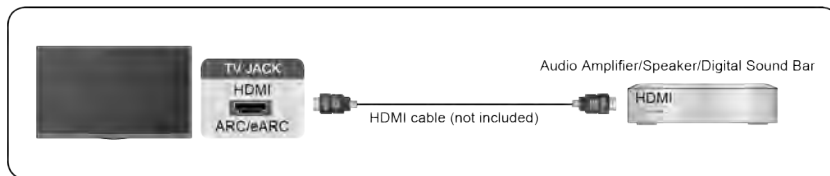

### Connecting a Digital Audio System to Use eARC/ARC

If you'd like to use the Enhanced Audio Return Channel (eARC) / the Audio Return Channel (ARC) feature to have sound sent from the TV back down an HDMI cable to a digital sound system, you can connect to the HDMI (eARC/ARC) port of your TV.



By using this feature, you will also be able to control the sound system with your TV remote instead of using multiple remotes for each device.

After the connection:

1. Power on the sound system.
2. Press  button to select  icon, and select **Sound > Audio Output > eARC/ARC**. If the device supports eARC function, first select **Sound > eARC** to set it to On.

Note:

- It works only when the TV is connected to the audio receiver that supports the eARC/ARC function.
- If the device has an Input Selector feature then make sure to change it to TV.
- When this port is used as the eARC/ARC function, it can be used as signal input when a DVD is connected to amplifier and the amplifier is connected to the TV at the same time. (Some amplifiers may not support series connection.)

### Connecting an AV device, a PC or a Game Console with an HDMI cable

You can connect an AV device, a PC or a Game Console with an HDMI cable.

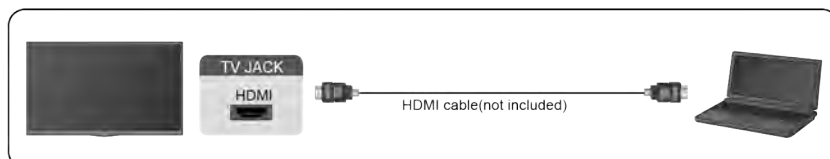

## Connection

After the connection:

1. Power on the device.
2. Press  button on your remote, select the corresponding **HDMI** as the input source.

Note:

- Refer to the "Quick Setup Guide" for more connection information.
- Some devices such as DVD player require HDMI signal to be set to output in the device's settings. Please consult your device user manual for instructions.
- If there is no sound from your TV, change the device's audio settings.

### Connecting USB Devices

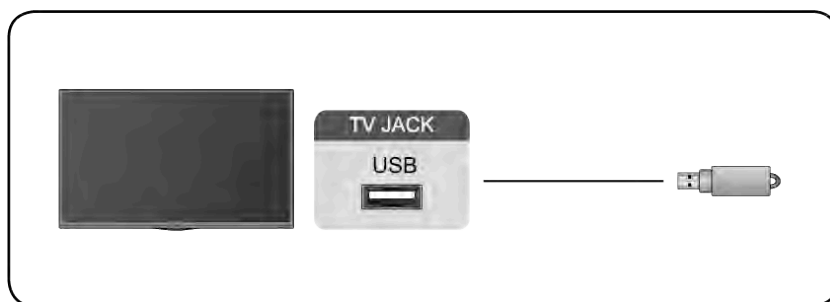

Connect the USB devices such as hard drives, USB sticks and digital cameras for browsing photos, listening to music.



- Support the USB disk 4G, 8G, 16G, 32G, 64G, 128G and other common market size, and 8T hard drive is currently supported.
- Support format: NTFS, FAT32.
- Certain digital cameras may not be compatible with the TV.

## Screen Sharing

Mirror content from your mobile device to the TV. View videos, photos and more from your device on your TV screen.

Press  button to select  icon, and select **Advanced System > Mobile Device Connection Tips > Screen Sharing**.

1. Turn on the casting function of your Android/Windows10 device. The setting icon may vary depending on the device. The feature may be called "Wireless display", "Smart view", "Wireless projection", etc.
2. Find the TV name in the searching list of your device and select it. Your mobile device's screen will be mirrored once you select your TV. If you are using WI-FI, the connecting may fail and the screen won't switch. You can close Screen sharing application with BACK or EXIT button.

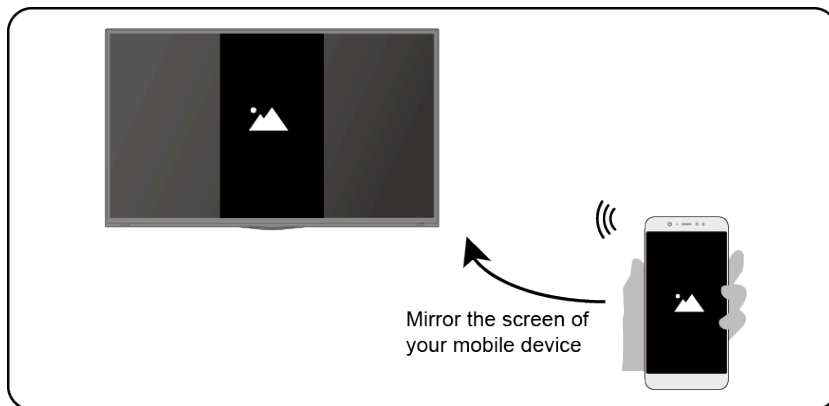

Note:

- Some mobile devices may not support casting.



## Content Sharing

Share videos, music or pictures from your Android/iOS/PC device to the TV screen.

Press  button to select  icon, and select **Advanced System > Mobile Device Connection Tips > Content Sharing**.

1. Make sure your device and the TV are connected to the same network.
2. Turn on the contents sharing function of your Android/iOS/PC device.
3. Find the TV name in the searching list of your device and select it.
4. Wait for the connection progress to complete, and select the content you want to share.

Note:

- Some devices may not support content sharing function. If your device doesn't support content sharing, you can download an app that supports the function, please refer to in this manual.
- The content may not be played depending on the file format.
- The content may not be played smoothly or the function may not work properly due to the network condition.

# Multi-screen

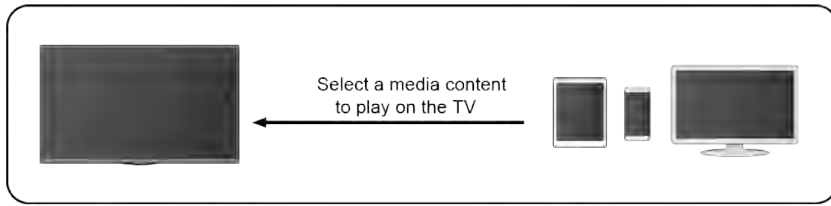

## Getting Familiar with the Home Screen

---

The simple design of the Home screen menu makes it easy to navigate. And you can easily add or delete applications in the Home screen according to your needs.

To access the Home screen, press  button on your remote and use the D-pad to make your selection.

To exit the Home screen, press  button on your remote or use the D-pad to move the cursor to  Inputs icon on the top of the screen, press  button to enter, and select your desired input source.

### Indicators and icons on the top of the Home screen

- **Google Assistant**

You can search movies, TV, and more by speaking.

- **Google Search**

You can search movies, TV, and more by typing.

- **Notifications**

Notifications can come from the system, an external device, an application, the media player, etc.

- **Inputs**

Select the input source depending on the device you have connected to your TV.

- **Network & Internet**

You can set up the Network & Internet.

- **Settings**

Settings lets you configure the TV, set app options, add accounts, and change other preferences.

- **Time**

You can always view the current time on the Home screen.

### Names of sections that appear on the Home screen

The Home screen displays the following sections:

- **Apps**

This is the a location where you have the access to all apps on your TV. You can enjoy a wide range of services including video streaming.

- **Play Next**

You can select types of content for Play Next.

You can also manually add a program to play next by long-pressing on a program in the Home screen.

- **Recommended content**

Here will display the premium content on the screen, and you can quickly enter these contents that you want.

### Managing apps on the apps row

On the apps row, select an app you want to open, remove or move, and long press  button to manage.



# Smart Functions

If your favorite app is not on your Home screen, select your favorite app and long press  button, and then select **Add to favorites**.

## Using Voice Control

---





Voice Control may not be applicable in some models/countries/regions.

### Google Assistant

Setup Google Assistant, and enjoy Google Assistant service. You can ask for information, search for your favorite movies, control your TV and more, just by asking Google Assistant.







Before setting up Google Assistant, connect your TV to the network.

#### Sign in Google Assistant on TV

1. Go to  >  **Settings > Device Preferences > Google Assistant**. Turn on Google Assistant.
2. Go to  >  **Settings > Accounts & Sign In**.
3. Sign in to get new apps, recommendations, movies, and more from Google. You can use your phone or computer, or use your remote to sign in. Also you can select Google Assistant in the Guide when you turn on the TV for the first time.

#### How to start Google Assistant

You can choose one way to start Google Assistant.



- Press  button to select  **Settings > Device Preferences > Google Assistant**.
- Press  button to select  /  icon on the top of Home screen to **Google Assistant**.
- Press  button on your remote.

Note:

- The Google Assistant function may not be applicable in some models/countries/regions.
- The setup steps above may vary depending on actual products.

### Hands-free Voice Control

Google Assistant can answer your questions or help you change TV configuration.

Before using this function, connect the TV to the Internet and sign in your Google account, by pressing  button, selecting  icon and selecting **Accounts & Sign In**.

#### How to set up Hands-free Voice Control

1. Switch the control button on the bottom of the TV to  to turn on Google Assistant.
2. Start a conversation by saying "Hey Google", and the dialog bar appears at the bottom of the TV screen. At the same time, indicator lights illuminate.
3. Continue speaking, such as "What's the weather" or "volume up".



#### Screenless mode

 >  **Settings > Advanced System > Screenless Mode**

Talk to Google Assistant even when the screen is off.

In Screenless Mode, Google Assistant is always available to help even when the screen is not on. Just say "Hey Google".

# Smart Functions

This feature will affect standby power consumption. To turn it off, press  button to select  icon, and select **Advanced System > Screenless Mode**.

Note:

- The Hands-free Voice Control function may not be supported in some models/countries/regions.
- The Screenless mode descriptions here is only applicable to the models with Hands-free Voice Control function.

## Alexa

Set up to control your TV with any Alexa-enabled devices. Alexa can help you change the TV configuration. Using just your voice, you can change inputs, volume, channels, and more. Just ask Alexa.



### What is required to control your TV with Amazon Alexa?

- Android TV models that support the Alexa skill.
- Amazon Echo device or Alexa App.
- Amazon account for Alexa App or Echo device, if you don't have the account, please create one before the setup process.
- Hisense account to link your TV, you can create it before the setup process or in the period.
- Home network with Wi-Fi capabilities.

Note:

- For issues of accessing your Amazon account and using the Alexa app during setup, please visit [amazon.com](https://amazon.com) for help.

### How to set up Alexa

1. Go to  >  **Settings > Advanced System > Amazon Alexa Service**.
2. Turn on Amazon Alexa Service.
3. Select **Amazon Alexa Service Setup** and **Set up now**.
4. Link the TV to Hisense account. Scan the QR code with your phone, or visit the website on your phone or computer, sign in your Hisense account, and enter the code showed on the TV. The webpage and code will be expired after 15 minutes.
5. Next, your TV screen shows a list of TV name. Select one from it or enter a custom name. Then, your TV will appear in the device name list on your phone or computer.
6. Download the Alexa app on your smart phone. Open the app and sign in with your Amazon account.
7. In the Alexa app, select Skills section, search and enable Hisense Smart TV skill. Follow the instructions to link your Amazon account by entering the same Hisense account that you've signed on your TV.
8. On your TV, select **Skill enabled** and **Done**.
9. Now, You can ask Alexa try some functions available for TV.

Note:

- Use external Alexa-enabled devices (e.g. Alexa App, Echo) to control your smart TV by using just your voice.
- After your Hisense account is created but you can't see the Link your TV step on your phone or computer, please sign out account and re-visit URL and sign in again.
- If you do not see "Amazon Alexa Service" in the System settings, then your TV does not support Alexa.
- The Alexa function may not be applicable in some models/countries/regions.

# Smart Functions

- The setup steps above may vary depending on actual products.

## Media

Media is a central location for you to view or listen to different types of content, such as photos, music and movies. You can view media content through the following methods:

- A USB thumb drive or hard drive.
- Compatible mobile phone, tablet or other personal devices: you can stream movies, music and photos that are stored on compatible personal device and play or view the content on your TV.

## Browsing content

You have two ways to enter Media:

- Insert a USB device, a prompt message appears, choose whether to go to the media.
- When your USB device is connected to the TV that doesn't show Media page, press  button to select **Apps > Media**.

To browse content based on the type that you wish to access:

1. Navigate to the appropriate menu tab on the screen and select All Media, Videos, Photos, Music.
2. Click on the name of the folder that contains your content.
3. Make your selection to play or view the content.

If you want to close out of the Media centre, then press  button on your remote.

## Media format list

Due to differences in programming tools and other factors, some of the file formats that are listed may not be supported.

### Video Format

Container	Video Codec	File Extension Name	Resolution and Frame Rate
MPG	MPEG1/2	.mpg .mpeg	1920 x 1080 @ 60fps
MPEG program stream	MPEG1/2	.DAT, .VOB, .MPG, .MPEG	3840 x 2160 @ 120fps
	MPEG4		
	H.264		
MPEG transport stream	HEVC/H.265	.ts, .trp, .tp	3840 x 2160 @ 120fps
	MPEG4		1920 x 1080 @ 60fps
	H.264		3840 x 2160 @ 120fps
	VC1		1920 x 1080 @ 60fps
	MPEG1/2		1920 x 1080 @ 60fps
MP4	VP8	.mp4, .mov	1920 x 1080 @ 60fps
	AV1		3840 x 2160 @ 120fps
	HEVC/H.265		1920 x 1080 @ 60fps
	MPEG1/2		
	MPEG4		

# Smart Functions

Container	Video Codec	File Extension Name	Resolution and Frame Rate
	H.263		3840 x 2160 @ 120fps 1920 x 1080 @ 60fps 1920 x 1080 @ 30fps
	H.264		
	WMV3		
	VC1		
	Motion JPEG		
MKV	VP9	.mkv	3840 x 2160 @ 120fps 1920 x 1080 @ 60fps 3840 x 2160 @ 120fps 1920 x 1080 @ 60fps 1920 x 1080 @ 30fps 1920 x 1080 @ 60fps 3840 x 2160 @ 120fps
	HEVC/H.265		
	MPEG1/2		
	MPEG4		
	H.264		
	WMV3		
	VC1		
	Motion JPEG		
	VP8		
	AV1		
AVI	HEVC/H.265	.avi	3840 x 2160 @ 120fps 1920 x 1080 @ 60fps 3840 x 2160 @ 120fps 1920 x 1080 @ 60fps 1920 x 1080 @ 30fps 1920 x 1080 @ 60fps
	MPEG1/2		
	MPEG4		
	Sorenson H.263		
	H.263		
	H.264		
	WMV3		
	VC1		
	Motion JPEG		
	VP8		
FLV	HEVC/H.265	.flv	3840 x 2160 @ 120fps 1920 x 1080 @ 60fps 3840 x 2160 @ 120fps 1920 x 1080 @ 30fps 1920 x 1080 @ 60fps
	MPEG4		
	Sorenson H.263		
	H.263		
	H.264		
	Motion JPEG		
	VP8		
WEBM	VP9	.webm	3840 x 2160 @ 120fps 1920 x 1080 @ 60fps 3840 x 2160 @ 120fps
	VP8		
	AV1		

# Smart Functions

## Audio Format

Container	Audio Codec	File Extension Name
WAV	MPEG1/2 Layer1	.wav
	MPEG1/2 Layer2	
	MPEG1/2/2.5 Layer3	
	AAC-LC, HEAAC	
	DTS, DTS HD	
	LPCM	
MP3	MPEG1/2 Layer1	.mp3
	MPEG1/2 Layer2	
	MPEG1/2/2.5 Layer3	
AAC	AAC-LC, HEAAC	.aac
WMA	WMA7, WMA8, WMA9	.wma, .wmv
	WMA Pro	
	WMA9 Pro	
FLAC	FLAC	.flac

## Photo Format

Image	Photo	Resolution
JPEG	.jpg .jpeg	15360 x 8640
	Progressive	1024 x 768
PNG		9600 x 6400
BMP		9600 x 6400
GIF		6400 x 4800
WebP		3840 x 2160
HEIF		4000 x 3000

## Apps

 > Apps

## Installing an app

To install an app:

1.  > **Apps** > **Get more apps**.
2. Use the D-pad on your remote to select the app that you want to install.
3. Select the **Install**. The selected app is installed on the TV.

Note:

- To use this function, your TV must be connected to the Internet.
- Adding apps is free, but it might cost you money when using some apps.

## Removing an app

You can only delete apps that you've installed to the TV. Factory-installed apps can not be deleted.

To delete an app:



1. From the Apps screen, use the D-pad on your remote to select the app that you want to remove. Long press  button.
2. Select **Uninstall**.
3. A dialog message displays that asks "do you want to uninstall this app". Confirm and the app will be removed from the Apps screen.

Note:

- If an app is deleted, the information related to that app is also removed.

## Moving app icons around

To move an app:

1. From the Apps screen, use the navigation buttons on your remote to select the app that you want to move. Long press  button.
2. Select **Move**.
3. Use the navigation buttons on your remote to move the location of the app. Press  button to confirm.

## Installing Mobile App to Control your TV

---

Press  button to select  icon, and select **Advanced System** > **Mobile App Installation**

You can scan the Mobile App download QR code on screen to install the app on your smartphone to control your TV, such as turning the TV on or off, typing in with your mobile's keyboard, and sharing pictures or videos from your mobile to TV. This app is available on both Android and iOS.



### To connect your TV after installing the mobile app:

1. Make sure your mobile phone and TV are connected in the same network environment.
2. To use this function, switch on **Content Sharing** at **Network & Internet** > **Content Sharing**.
3. Open the mobile app and select the TV device you want to connect.

## Adjusting the Picture Quality

---

### Using the Laser Luminance function

Press  button to select  icon, and select **Picture > Laser Luminance**.

You can change the overall brightness of the screen.

- **Laser Luminance Level**

Adjust the bright you want images to appear, lower settings create darker images.

- **Automatic Light Sensor**

Enable the TV to automatically adjust the picture settings according to the amount of ambient light in you room.



- **Light Sensor Shift**

Adjust the lower point of the dynamic laser luminance adjustment scope. This is a money-saving feature because it reduces power consumption.

Note:

- Some functions above may not be applicable in some models/countries/regions.

### Choosing a picture mode

Press  button to select  icon, and select **Picture > Picture Mode**.

You can select the picture mode that provides the best viewing experience.

### Low Blue Light

Theater Day and Theater Night are designed to reduce the level of blue light to protect your eyes.

Go to  >  **Settings > Picture > Picture Mode**, and select **Theater Day/Theater Night**.

To reduce the eye strain and protect eyes when you watch TV for a period of time, you are suggested to:

- Take regular and frequent breaks to avoid watching TV for a long period of time. Long time of watching may cause you eye fatigue. It is not recommended to watch TV for more than one hour.
- Look away from the TV screen and look at distance objects during the breaks for at least 10 minutes for eye care.
- Relax yourself during a break by doing eye exercises or outdoor activities.
- The best recommended viewing distance is 3 times the vertical height of the TV screen.

Proper breaks and exercises are proved excellent help to relieve eye strain and fatigue.

Note:

- This feature may not be applicable in some models/countries/regions. Low blue light certification may vary by model.
- Low Blue Light can only be supported when the Color Temperature is set to **Low**.

### Adjusting the picture quality for each picture mode

Press  button select  icon, and select **Picture > Contrast, Brightness, Color, Tint or Sharpness**.

Choose a picture mode and then adjust the settings.

# Picture and Sound

- **Contrast**

Adjust the Contrast level to increase or decrease how bright images appear.

- **Brightness**

Adjust the Brightness level to generate lighter or darker images.

- **Color**

Adjust the color intensity of the picture for a more vibrant image.

- **Tint**

Adjust the colors from a green to magenta tint to view the natural skin tones of people on the screen.

- **Sharpness**



Adjust how sharp or soft edges of images appear.

## Changing the picture size

Press  button to select  icon, and select **Picture > Picture Size**



You can adjust the Aspect Ratio to stretch or zoom in on your picture. You can choose from the following settings: **Auto**, **Normal**, **Zoom**, **Wide**, **Direct**, **Dot-By-Dot**, **Panoramic** or **Cinema**.

## Applying the current picture settings to other input sources

Press  button to select  icon, and select **Picture > Apply Picture Settings**.

Adjust current picture mode to apply to all sources (Including both external devices and OTT sources) or just current source.

## Enabling smart scene function



Press  button to select  icon, and select **Picture > Smart Scene**.

Set to On to enable your TV to recognize the scene in the content watching and enhance the picture quality on all input sources.

Note:

- Some specific application has explicit constraints that the content recognition is not allowed.

## Configuring advanced picture settings

Press  button to select  icon, and select **Picture > Advanced Settings**.

You can configure picture mode settings that provides the best viewing experience.

- **Overscan**

Change the video size settings to slightly crop the edges of the displayed image.

- **Color Temperature**

Adjust how warm (red) or cool (blue) the white areas of an image appears.

- **Motion Enhancement**

Reduce seeing afterimages that are left on the screen when viewing fast-moving objects.

If you select **Custom**, you can configure **Blur Reduction** and **Judder Reduction** manually.

- **Motion Clearness**

Improve how clear the picture appears when viewing.



## Picture and Sound

- **Noise Reduction**  
Improve how clear the picture appears by reducing noise.
- **Digital Noise Reduction**  
Improve picture clarity by reducing video noise.
- **HDMI Dynamic Range**  
Adjust the HDMI signal range to be more suitable for the content. (HDMI mode only)
- **Active Contrast**  
Automatically darken dark areas and lighten light areas of images to see more details.
- **FILMMAKER MODE Auto Detection**  
A picture quality mode, which can automatically switch according to the film source if you turn on.
- **Enhanced Viewing Angle**  
Set to On to optimize your viewing angle, and you will enjoy a better watching experience.
- **Color Space**  
Change the range of colors the TV displays.
- **Instant Game Response**  
You can enjoy a smooth viewing experience with external device connected to the TV.

Note:

- Some functions above may not be applicable in some models/countries/regions.

### Configuring calibration settings

Press  button to select  icon, and select **Picture > Calibration Settings**.

Adjust the color space and Gamma to best suit the content you're viewing.

- **Color Tuner**  
Adjust the Color, Hue, Saturation and Brightness of color settings.
- **White Balance**  
Adjust the intensity of red, green and blue lights to view the true colors of all images in the picture.
- **Gamma**  
Adjust the Gamma to alter how the TV will respond to the grayscale content. In general, 2.2 is normally recommended.
- **Gamma Calibration**  
Adjust selected Gamma curve.
- **RGB Only**  
View images based on default settings or choose the color red, blue or green.

Note:

- Some functions above may not be applicable in some models/countries/regions.

### Resetting the picture settings



Press  button to select  icon, and select **Picture > Reset**.

Reset current picture settings back to the factory setting.

## Game Mode Settings

---

### Enabling game mode

Press  button to select  icon, and select **Picture > Picture Mode**.

You can select the **Game** mode to optimize the TV's settings for you to enjoy a comfortable gaming experience with PC or game console connected to the TV.

In the Game Mode:

- Reducing input lag to make sure every press or click matches what's happening on the screen;
- Improving responsiveness to produce very little motion blur;
- Processing YUV 4:4:4 format signals precisely to present accurate image colors.

Note:

- This function may not be applicable in some input sources.

### Enabling instant game response

Press  button to select  icon, and select **Picture > Advanced Settings > Instant Game Response**.

You can enjoy a smooth viewing experience with external device connected to the TV when **Instant Game Response** is turned on.

Note:

- When Game mode is selected, Instant Game Response will not be switched off automatically.

### Enabling FreeSync

Press  button to select  icon, and select **Picture > Advanced Settings > FreeSync**.

You can enjoy a smooth viewing experience with external device connected to the TV when **FreeSync** is turned on.



Note:

- This function may not be applicable in some models/countries/regions.

## Adjusting the Sound Quality

---

### Enabling system sounds

Press  button to select  icon, and select **Sound > System Sounds**.



Set to On to open the default system sound.

### Choosing a sound mode

Press  button to select  icon, and select **Sound > Sound Mode**.



You can select a preset sound mode suitable for the content type or the listening environment.

### Selecting speakers

Press  button to select  icon, and select **Sound > Audio Output**.

Select the speakers that you want to have audio output.

## Configuring WiSA Speaker

Press  button to select  icon, and select **Sound > WiSA Speaker Settings**.

Wireless audio transmission can be available with Dongle provided by WiSA Ready and sound system certified by WiSA Ready.

## Enabling eARC

Press  button to select  icon, and select **Sound > eARC**.

Connect an audio device that supports eARC via HDMI-eARC, and set eARC to On to enjoy premium sound quality.



## Enabling TV speaker

Press  button to select  icon, and select **Sound > TV Speaker**.

Turn on or off the TV speaker.



If ARC or Bluetooth is selected in Audio Output, configuration here is unavailable.

## Enabling TruBass HDX

Press  button to select  icon, and select **Sound > TruBass HDX**.



Optimizes overall sound quality by increasing bass, making dialog clear and natural, and widening the sound field.

## Enabling TruSurround: X

Press  button to select  icon, and select **Sound > TruSurround: X**.



Provides surround sound experience with psycho-acoustic processing to place sounds beside, behind, and above the viewer. For best results use with Surround Sound.

## Enabling Dialog Clarity

Press  button to select  icon, and select **Sound > Dialog Clarity**.



Improve dialogue clarity.

## Enabling TruVolume HD

Press  button to select  icon, and select **Sound > TruVolume HD**.



Maintains consistent loudness levels from wide dynamic range programs, loud commercials, and channel or input changes.

## Enabling Dolby Atmos

Press  button to select  icon, and select **Sound > Dolby Atmos**.



Set Dolby Atmos to On to enhance the richness of sound, and you can enjoy an immersive listening experience.

## Enabling Wall Mount Setup

Press  button to select  icon, and select **Sound > Wall Mount Setup**.

Automatically optimize the sound based on the position of the TV.

## Configuring advanced sound settings

Press  button to select  icon, and select **Sound > Advanced Settings**.

Tune the audio settings and quality of the TV.

- **Balance**

Adjust the left and right speaker strength to optimize audio for a specific location.

- **Volume Level**

Balance the sound volume of each source.

- **Auto Volume Control**

Activate to prevent the volume from changing when you switch TV channels.

- **Digital Audio Out**

Select the digital audio output format that best suits the audio device type.

Note:

- When using optical connection, PCM and Dolby Digital are suggested.
- If your external audio device does not support Dolby or DTS, PCM is suggested.

- **Digital Audio Delay**

Adjust the digital audio output delay time to sync sound from an external speaker with the images on the TV.

Note:

- Digital Audio Out and Digital Audio Delay functions are only applicable when Audio Output is set to ARC or when external audio players are connected via DIGITAL AUDIO OUT jack.

- **Lip Sync**

Synchronize the displayed image with the audio output.

- **Equalizer**

Boost the volume at different frequencies.

- **Preferred Audio Language**

Set the default audio output language for the type of digital broadcast content that you're viewing.

- **Headphone Mode**

Change the way audio is sent through the type of device that's connected to your TV Audio Out port.

Note:

- This function may not be applicable in some models/countries/regions.

- **Headphone Volume**

Independently adjust the volume of audio out devices.

Note:

- This function may not be applicable in some models/countries/regions.



## Resetting the sound settings

Press  button to select  icon, and select **Sound > Reset**.

Reset current audio settings to factory mode.

## Accessibility

---

Press  button to select  icon, and select **Device Preferences > Accessibility**.

Accessibility function provides menu options and audio description to aid the visually or hearing impaired.

- **Captions**

Displays and sets the closed captions. You can set display options and select caption style.

- **Live TV Closed Captioning**

- Displays and sets the TV closed captions. (This function may not be applicable in some models/countries/regions. )
- Closed Caption
- Analog Closed Caption
- Digital Closed Caption
- Digital Caption Style

- **High contrast text**

Improves contrast for visually impaired.

- **Video Description**

Enables broadcasted descriptive audio for visually impaired.

- **Video Description Volume**

Adjust the video description volume.

- **Text to speech**

Let you specify text-to-speech engine details and speech rate.

- **Accessibility shortcut**

When the shortcut is on, you can press both the back and down buttons for 3 seconds to start an accessibility feature.

Note:

- This function may not be supported in some countries/regions/models.

- **Services**

This menu function contains some service applications, you can choose to open if you need it.

## Using Parental Control

---

Press  button to select  icon, and select **Parental Control**.

The Parental Control setting allows you to block content that is not appropriate for children to watch.

- **Locks**

### Turning Parental Control On

1. Turn on Locks to enable the Parental Control function.
2. Create PIN window displays. Using the D-pad on your remote, create the password.
3. You will see other Parental Control settings change from a greyed out state to highlighted. When this occurs, begin adding other settings to the **Block Time**, **Channel Block**, **Program Block**, **Input Block**, **Change PIN** and **Reset** features.

- **Block Time**  
Block certain channels, programs and inputs during certain periods of time.
- **Channel Block**  
Block selected channels.
- **Program Block**  
Block programs by ratings.
- **Input Block**  
Block selected inputs.
- **Change PIN**  
Change the PIN that you use to access Parental Control.

Note:

If you forget your password, call the Consumer Electronics Care Centre.

- **Reset**  
Reset Parental Control back to the factory setting.

## Configuring Device Preferences Settings

---

Press  button to select  icon, and select **Device Preferences**.

### Date & time

- **Automatic date & time**  
Set to On to use network provided time.  
You can also set the current time manually when Off is selected.  
When Off is selected, the TV Network may not be working properly.
- **Set date**  
Set the date.
- **Set time**  
Set the time.
- **Set time zone**  
Select your time zone.
- **Use 24-hour format**  
Set the time to display in a 12 or 24-hour format.

### Language

Adjust the default Language settings for the TV.

### Keyboard

Adjust the default settings for the keyboard.

### Storage

View the TV storage.

## Home screen

- **Customize channels**  
Add or delete the app channel row from the Home screen.
- **Enable video previews**  
Enable or disable the video previews.
- **Enable audio previews**  
Enable or disable the audio previews.
- **Reorder apps/Reorder games**  
Rearrange the Apps screen.
- **Android TV Home/Android TV Core Services**  
See the information of open source software licences.

## Google Assistant

View permissions about accounts and limit the search results.

## Chromecast Android Shell (Chromecast built-in)

Enable your app to stream video and audio to the TV.

## Screen saver

Enable Screen saver when the TV is idle.

## Location

Use different modes to access location information. Each mode uses different sources to estimate the TV's location.

## Usage & Diagnostics

Help improve Android performance by automatically sending diagnostics information.

## Security & restrictions

Supervise unknown sources for safety and check installed apps for harmful behaviour.

## Reset

Reset to clear your personal setup and information.

## About

View the version information, the status of network, and other information. You can also update the software version or change the TV's name.

- **System update**  
Provide software updates to continuously enhance your TV and correct any issues that may impact your user experience; therefore, recommend you to keep your TV connected to the Internet to automatically receive updates when they are available.
- **Device name**  
Choose a name for your TV. The name will be shown to devices that are available for sharing data.

## Configuring Advanced System Settings

---

Press  button to select  icon, and select **Advanced System**.

### Timer

- **Sleep Timer**

Set the sleep timer to automatically turn the TV off within a specified time: off, 10 Minutes, 20 Minutes, 30 Minutes, 40 Minutes, 50 Minutes, 60 Minutes, 90 Minutes and 120 Minutes.

- **Power On Timer Type**

Set the type Off, Daily, Once.

- **Power On Timer**

Set the clock for the time you want the TV to turn on automatically.

- **Power Off Timer Type**

Set the type Off, Daily, Once.

- **Power Off Timer**

Set the clock for the time you want the TV to turn off automatically.

### Setup Assistant

Use the Setup assistant for instructions to help you set up your TV.

### Store Mode

Home Mode uses less energy. Select Store Mode if the TV will be on display in a retail setting. Store Mode effects E-Streamer and other demo functions.

### Screenless Mode

By turning Screenless Mode On or Off, you can enable or disable the WOW、WOL、WOC functions. When Screenless Mode is set to Off, you will not be able to remotely wake up the TV through external devices.

If your models support Hands-free Voice Control function, you can talk to the Google Assistant even when the screen is off. In screenless Mode, the Google Assistant is always available to help even when the screen is not on. Just say "OK Google/Hey Google". This feature will affect standby power consumption when it is set to On.

Note:

- The Google Assistant and some features are available on limited country/region/language.

### Send Diagnostics and Usage

Allow to send the diagnostics and usage of the report.

### Enhanced Viewing

You can set Automatic Content Recognition, Picture Mode Auto Adaptation and Sound Mode Auto Adaptation.

Note:

- To use Enhanced Viewing, connect your TV to network first.
- This function may not be applicable in some models/countries/regions.



## Serial/IP Control Port

Our TV supports IP control feature within the local area network (LAN). TV can accept the spec-compliant instructions issued by the device in the same local area network through the pre-defined network interface and command format, like shutdown, volume up/volume down, switch channels, etc.

## Control4 Control Port

TV can be compatible with control 4 devices. Control and linkage between devices can be achieved through drivers and protocols provided by Control 4.

Note:

- This function may not be applicable in some models/countries/regions.

## Power LED

Set the Power indicator light to stay On or Off when standby mode.

Note:

- This function may not be applicable in some models/countries/regions.

## Power on Mode

TV will be powered on based on the mode when TV is reconnected with AC power.

Note:

- This function may not be applicable in some models/countries/regions.

## FAV/TV Button Customization

You can personalize FAV/TV remote button for quick access to customized input source.

Note:

- This function may not be applicable in some models/countries/regions.

## Product Registration

Visit the link or scan the QR code with another smart device (cellphone, tablet..) to complete your registration.

Note:

- The link and the QR code may be different in some countries/regions.

## Remote Control Service

Remote Service features enable your TV to be controlled from the client server to let after-sales diagnose the problem of your TV and dealing with the problem online efficiently. To use this function:

1. Turn on **Remote Control Service**.
2. You can initiate a help request to call centres by hotline and provide PIN to the client server centre.

Note:

- This function may not be applicable in some models/countries/regions.
- Keep the network connected when the Remote Control Service is running.

## E-Manual

Scan QR code to display E-Manual.

## Mobile App Installation

Scan the Mobile App download QR code on screen to install the app on your smartphone to control your TV.

For more about RemoteNOW Download settings, Please refer to [Installing Mobile App to Control your TV](#) section in this manual.

## Mobile Device Connection Tips

Follow the on-screen instructions to learn more about the Screen Sharing and the Content Sharing.

## Clear Cache

Clear cache of applications and system.

## Help

- **System Message**

View system message, including: Serial Number, Service Code, Software Version, etc.

Note:

- Serial Number may not be displayed depending on models/countries/regions.

- **Support Information**

View Support URL, Support Number.

- **Signal Information**

Perform self diagnosis to test Video Format, Audio Format, Color Depth, etc.

## Projection Mode

---

If you need to flip the image over top-to-bottom and/or left-to-right, press  > **Screen** > **Projection Mode** to select by pressing the UP/DOWN buttons on the remote.

## Screen Type

---

Different screen types have different picture quality.

Press  > **Screen** > **Screen Type**, select the corresponding type according to the actual screen used.

After the setting is complete, you need to restart Laser TV to take effect.

## Auto Geometric Correction

---

The Laser TV will fit the projected image into the screen automatically.

Before you use automatically geometric correction function, ensure that the Laser TV and your mobile device are connected to the same Wi-Fi network.

 > **Screen** > **Auto Geometric Correction**

## Accessibility and System

1. Position the Laser TV and use the leveling feet as needed to fit the entire display border within the screen area.
2. Select **Next** to continue.
3. Scan the QR Code with your mobile device to begin automatic geometric correction. When the app loads, the Laser TV will display an alignment grid.

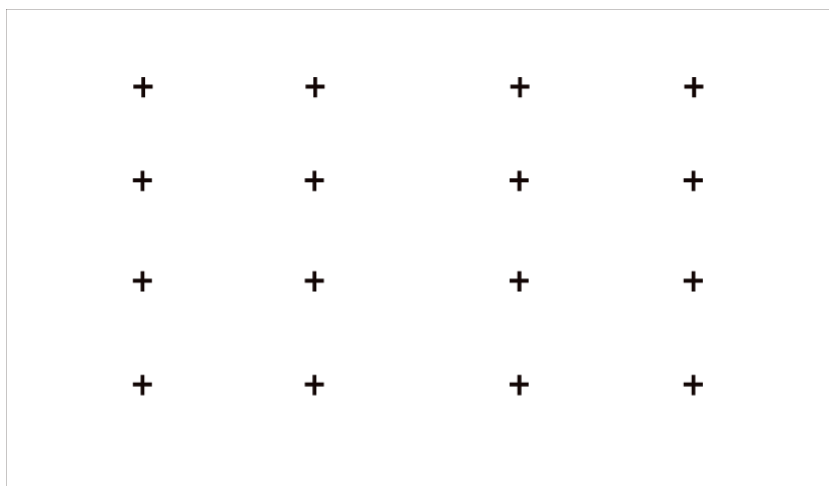

Alignment grid

4. Click "+" on your mobile device to take a photo of the entire screen and image. For best results, stand about 10 feet away from the screen and use landscape mode.
5. Click "**upload**" on your mobile device to complete the automatic geometric correction.

## Geometric Correction









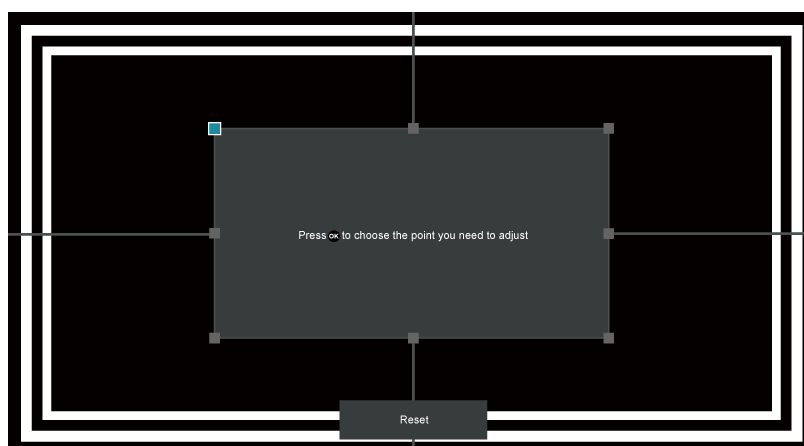





Select points and move it to fit the projected image into the screen.

Note:

Geometric Correction is only applicable in some models/countries/regions.

☰ > Screen > Geometric Correction



1. Press  /  /  /  buttons on your remote to move focus, and press  button to choose a point you need to adjust.
  2. Long press  /  /  /  buttons: quick adjustment of the projected image; Short press  /  /  /  buttons: precise adjustment of the projected image.
  3. Press  button to save your adjustment, and you can select other points to adjust the image.
- If you want to return the image position to the factory default, select **Reset** button on the screen.

## Eye Protection

---

Note:





- In order to protect your eyes, do not look into the lens. The light output will be temporarily disabled after 5 seconds.

Press  > **Screen** > **Eye Protection** you can choose to enable this function on or off.

# Troubleshooting

## Picture Issues

When the TV has picture problems, these steps may help resolve the problem.

Problem	Possible Solutions
No picture, or black and white picture.	<ul style="list-style-type: none"><li>• Unplug the TV power cord from AC outlet and re-plug after 60 seconds.</li><li>• Check that the Color Saturation is set to 50 or higher.</li><li>• Try different TV channels.</li></ul>
The picture is distorted.	<ul style="list-style-type: none"><li>• The compression of video content may cause picture distortions, especially in fast-moving pictures from sports programmes and action movies.</li><li>• If the signal reception is weak or poor, screen distortion may be visible but it is not a malfunction.</li><li>• Mobile phones used close to the TV (within 1m) may cause noise on analogue and digital channels.</li></ul>
The picture is blurry or flickering, or cuts out momentarily.	<ul style="list-style-type: none"><li>•  &gt;  <b>Settings &gt; Picture &gt; Sharpness.</b> You can try to increase or decrease the <b>Sharpness</b>.</li><li>• If you use an external antenna, check the direction, position and connection of the antenna.</li><li>• Adjust the direction of your antenna, or reset or fine tune the channel.</li></ul>
The picture appears red, purple, pink and other colors.	<ul style="list-style-type: none"><li>•  &gt;  <b>Settings &gt; Picture &gt; Calibration Settings &gt; White Balance.</b> You can try to increase or decrease the <b>White Balance</b>.</li></ul>
Picture distorted or appear wavy.	<ul style="list-style-type: none"><li>• Some electrical appliances may affect the TV. If you turn off the appliance and the interference goes away, then move it further away from TV.</li><li>• Insert the power plug of the TV into another power outlet.</li></ul>

Note:

- If the problem persists, check the signal strength or refer to the external device's user manual.

## Sound Issues

When the TV has a sound problem, these steps may help resolve the problem.

Problem	Possible Solutions
There is no sound or the sound is too low at maximum volume.	<ul style="list-style-type: none"><li>• Check the volume control of the device (cable or satellite box, DVD, Blu-ray, etc.) connected to your TV.</li></ul>
Picture is normal, but no sound.	<ul style="list-style-type: none"><li>• Check the volume settings.</li><li>• Check if 'Mute' mode is set to on.</li></ul>
The speakers are making an odd sound.	<ul style="list-style-type: none"><li>• Make sure that the audio cable is connected to the correct audio output connector on the external device.</li><li>• For antenna or cable connections, check the signal information.</li><li>• A low signal level may cause sound distortions.</li></ul>
Sound distorted or appears wavy.	<ul style="list-style-type: none"><li>• Some electrical appliances may affect the TV. If you turn off the appliance and the interference goes away, then move it further away from TV.</li><li>• Insert the power plug of the TV set into another power outlet.</li></ul>

# Troubleshooting

Problem	Possible Solutions
Sound is blurry or cuts out momentarily.	<ul style="list-style-type: none"> <li>If you use an external antenna, check the direction, position and connection of the antenna.</li> <li>Adjust the direction of your antenna or reset or fine tune the channel.</li> </ul>

Note:

- This product does not support decoding of DTS CD bitstreams. Playback of this format may produce undesirable noise.



## Network Issues

When the TV has difficulties in connecting to the Internet, these steps may help resolve the problem.

Problem	Possible Solutions
The TV cannot connect to your network or apps.	<ul style="list-style-type: none"> <li>Make sure the TV has a network connection.</li> <li>Contact your Internet service provider.</li> </ul>
The wireless network connection fails.	<ul style="list-style-type: none"> <li>Make sure your wireless modem/router is on and connected to the Internet.</li> </ul>
The wireless network signal is too weak.	<ul style="list-style-type: none"> <li>Position your wireless router, modem router, or access point in a central location. Avoid putting it in a corner.</li> </ul>

## External Device Connection Issues

When the TV has difficulties with external device connection, these steps may help resolve the problem.







Problem	Possible Solutions
I have connected an external source to my TV but I get no picture and/or sound.	<ul style="list-style-type: none"> <li>Check whether the connection between the external device and your TV is correct.</li> <li>Make sure you have made the correct selection of input source.</li> </ul>
There is no signal or weak signal in the cable box.	<ul style="list-style-type: none"> <li>If there is no signal occasionally, unplug cable from TV and re-plug after 60 seconds.</li> <li>If there is always no signal, or the signal cannot be restored after plugging and unplugging, you can try <b>Menu &gt; HDMI Format</b> if you select HDMI as input, to confirm whether the signal can be recognized.</li> <li>Change to another HDMI port.</li> <li>Change to another HDMI cable.</li> </ul>
There is no sound.	<ul style="list-style-type: none"> <li>Check if the Audio Out option in the menu is ARC/eARC, if not, you need to check whether the external power amplifier device is connected to the ARC port or optical port of the TV.</li> <li> &gt;  <b>Settings &gt; Sound &gt; Advanced Settings &gt; Digital Audio Out</b>. You can try to select PCM, Dolby Digital, or Dolby Digital Plus.</li> <li>Whether the power amplifier device port is connected correctly.</li> <li>If you select HDMI as input, you can try <b>Menu &gt; HDMI Format</b></li> </ul>

# Troubleshooting

Problem	Possible Solutions
The remote control does not work.	<ul style="list-style-type: none"><li>• Confirm that TV still has power and is operational.</li><li>• Change the new batteries in the remote control.</li><li>• Check if the batteries are correctly installed.</li><li>• If some buttons don't work, but the volume buttons can work normally, it seems there is a problem with the application.</li></ul>

## Apps

When some apps aren't playing, these steps help resolve the problem.

Problem	Possible Solutions
Youtube can't be played.	<ul style="list-style-type: none"><li>•  &gt;  <b>Settings &gt; Apps &gt; Youtube &gt; Force stop</b>, then reopen to try.</li><li>• You can try to reset to the factory settings.</li></ul>
Prime Video can't be played.	<ul style="list-style-type: none"><li>•  &gt;  <b>Settings &gt; Apps &gt; Prime Video &gt; Force stop</b>, then reopen to try.</li><li>•  &gt;  <b>Settings &gt; Apps &gt; Prime Video &gt; Clear data</b>, then reopen to try.</li><li>• You can try to reset to the factory settings.</li></ul>

## Media Files

When files aren't playing, these steps may help resolve the problem.

Problem	Possible Solutions
Some files can't be played.	<ul style="list-style-type: none"><li>• Most files can be played back, but you might experience problems with corrupted files or files with high-bitrate, unsupported resolution, unsupported container or codec formats.</li></ul>

## Voice Control Issues

When Alexa and Google Assistant aren't playing, these steps may help resolve the problem.

Problem	Possible Solutions
Alexa can't be played.	<ul style="list-style-type: none"><li>• For more information about Alexa, refer to <a href="#">Smart Functions &gt; Using Voice Control &gt; Alexa</a> in this manual.</li></ul>
Google assistant can't be played.	<ul style="list-style-type: none"><li>• You can try to log in Google account.</li><li>• If you receive "I don't understand" of the voice recognition, please change account or log out the account.</li><li>• After logging in to the Google account, the recognition language may be different. You need to log in to the Google account on the web page to set the voice language.</li><li>• For more information about Google Assistant, please refer to <a href="#">Smart Function &gt; Using Voice Control &gt; Google Assistant</a> in this manual.</li></ul>

# Troubleshooting

## Other Issues



Use these steps to resolve other issues that may occur.

Problem	Possible Solutions
<b>The TV is hot.</b>	<ul style="list-style-type: none"><li>• Watching TV for an extended period of time causes the panel to generate heat. The heat from the panel is dissipated through internal vents running along the top of the TV.</li><li>• After extended use, you may feel hot when touching it. This heat, however, is not a defect and does not affect the TV's functionality.</li></ul>
<b>The TV smells of plastic.</b>	<ul style="list-style-type: none"><li>• This smell is normal and will dissipate over time.</li></ul>
<b>The plastic cabinet makes a "clicking" type of sound.</b>	<ul style="list-style-type: none"><li>• The "clicking" sound can be caused when the temperature of the TV changes. This change causes the TV cabinet to expand or contract, which makes the sound. This is normal and the TV is OK.</li></ul>
<b>When I turn on my TV, there is a delay for a few seconds before the picture appears. Is this normal?</b>	<ul style="list-style-type: none"><li>• Yes, this is normal. The TV is initializing and searching for previous setting information.</li></ul>



## Launching the E-Manual

---

Press  button to select  icon, and select **Advanced System > E-Manual**.

Scan the QR Code with your smart phone to browse the E-Manual.

Disclaimer:

Instructions and images through this manual are only for reference and may differ from the actual product.

## Using the Buttons in the E-Manual

---

### Search

You can use  icon on the top of the E-Manual home screen to search for the product feature information, and the E-Manual will provide all the titles and content that contains the search information.

### Setting

You can use  icon on the top of the E-Manual home screen to adjust the text size.